

CLEANING EQUIPMENT

FLOATING DISPENSER



540001 **Floating dispenser STANDARD**, large design, with adjustment ring, see-thru cover, carries tablets up to 1 kg
Volume: 0,07 m3 Weight: 5,6 kg Packing: 12



540002 **Floating dispenser DELUXE**, deluxe design, with adjustment ring, see-thru cover, carries tablets up to 1 kg

Rabat Group

A

A

TEST SETS



540003 **Test kit** for Cl + pH with large 20 ml bottles, larger case
Volume: 0,007 m3 Weight: 1,9 kg Packing: 10

540004 **Replacement bottle Cl**
Volume: 0,002 m3 Weight: 2,3 kg Packing: 25

540005 **Replacement bottle pH**
Volume: 0,002 m3 Weight: 2,3 kg Packing: 25

540006 **Test kit for Cl + pH** with tablets (20 of each), larger case
Volume: 0,007 m3 Weight: 1,6 kg Packing: 10

540007 **Replacement tablets Cl**
Volume: 0,001 m3 Weight: 0,9 kg Packing: 500

540008 **Replacement tablets pH**
Volume: 0,001 m3 Weight: 0,9 kg Packing: 500

Rabat Group

A

A

A

A

A

A

THERMOMETERS



540009 **Thermometer round** for in-depth reading 30 cm below water level, floating ring
Volume: 0,17 m3 Weight: 11 kg Packing: 20



540010 **Thermometer**, Heavy- duty design with floating head
Volume: 0,02 m3 Weight: 1,5 kg Packing: 28

Rabat Group

A

A

VAC HEADS



540011 **Vac head DELUXE**, ABS 29 cm wide, 10 brushes, heavy design - 1,25 kg, 32/38 mm connection
Volume: 0,02 m3 Weight: 8 kg Packing: 6

Rabat Group

A

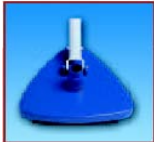

540012 **Vac head TRIANGULAR**, 30 cm wide, 3 replaceable brushes, sandweighted, swivel joint, 32/38 mm connection
Weight: 1,5 kg
Volume: 0,04 m3 Weight: 10 kg Packing: 6

A



540013 **Above-ground pool vac head**, economy model, no weights, 32/38 mm connection, weight: 0,3 kg
Volume: 0,06 m3 Weight: 7,5 kg Packing: 24

A

LEAF SKIMMERS & BRUSHES



540014 **Leaf skimmer**, all-plastic, unbreakable, strong net
Volume: 0,08 m3 Weight: 4,2 kg Packing: 20

Rabat Group

A



540015 **Leaf rake**, all-plastic, unbreakable, strong net
Volume: 0,08 m3 Weight: 5,2 kg Packing: 15

A



540016 **Wall brush curved**, all-plastic, 45 cm wide
Volume: 0,05 m3 Weight: 4,5 kg Packing: 12

A



540017 **Algae brush**, unbreakable plastic bristles, 16 cm wide
Volume: 0,04 m3 Weight: 5,0 kg Packing: 30

A



540018 **All-purpose scrubber**, tough, heavy duty, good for calcium deposits
Volume: 0,005 m3 Weight: 3,8 kg Packing: 10

A

HOSES & HANDLES

Rabat Group



540019 **Hose Ø 38 mm** - 100 m roll with integrated cuffs every 1,5 m, blue
Volume: 0,3 m3 Weight: 23 kg Packing: 1

A



540020 **Tele handle 1,8 - 3,6 m**
Volume: 0,04 m3 Weight: 12 kg Packing: 10

A

540021 **Tele handle 2,4 - 4,8 m**
Volume: 0,05 m3 Weight: 15 kg Packing: 10

A

MAINTENCE KITS



540022 **Kit 1** - Test kit, thermometer, vac head TRIANGULAR, leaf skimmer, wall brush
Volume: 0,13 m3 Weight: 13 kg Packing: 5

**Rabat
Group**

A

540023 **Kit 2** - Test kit, thermometer deluxe design, vac head, 8 brushes, leaf skimmer with alu-frame, wall brush
Volume: 0,13 m3 Weight: 11 kg Packing: 5

A



540024 **Kit 3** - Test kit, thermometer with floating head, vac head 8 wheels, leaf skimmer, wall brush
Volume: 0,13 m3 Weight: 12 kg Packing: 5

A

540025 **Economy-kit** - for above ground pools, 2 x 60 cm handles with coupler, test set, brush, leaf rake, thermometer

A

LADDERS

Stainless steel V2A Ø 43 mm handrail shiny polished. Stainless steel steps.
PVC anchorages.

MODEL STANDARD WITH ANATOMIC TREADS



Code	Steps	Dimensiones: mm						Rabat Group
		a	b	c	d	e	f	
610022	2	664	610	250	696	200	500	C
610023	3	664	610	250	946	200	500	C
610024	4	664	610	250	1196	200	500	C
610025	5	664	610	250	1446	200	500	C

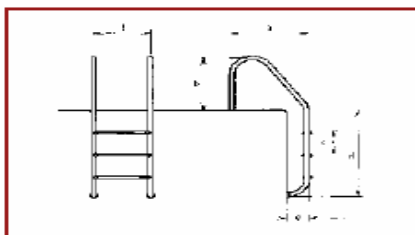

MODEL STANDARD WITH NON-SLIP TREADS



Code	Steps	Dimensiones: mm						Rabat Group
		a	b	c	d	e	f	
610001	2	664	610	250	696	200	500	C
610002	3	664	610	250	946	200	500	C
610003	4	664	610	250	1196	200	500	C
610004	5	664	610	250	1446	200	500	C

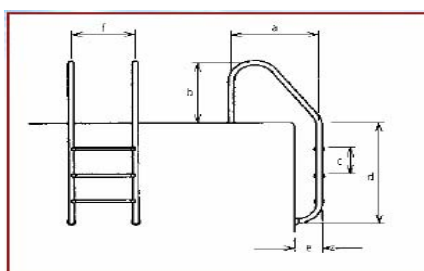

MODEL MURO WITH ANATOMIC TREADS



Code	Steps	Dimensiones: mm						Rabat Group
		a	b	c	d	e	f	
610026	2	357	610	250	696	200	500	C
610027	3	357	610	250	946	200	500	C
610028	4	357	610	250	1196	200	500	C
610029	5	357	610	250	1446	200	500	C

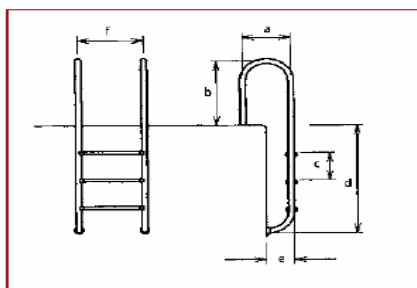

MODEL MURO WITH NON-SLIP TREADS



Code	Steps	Dimensiones: mm						Rabat Group
		a	b	c	d	e	f	
610005	2	357	610	250	696	200	500	C
610006	3	357	610	250	946	200	500	C
610007	4	357	610	250	1196	200	500	C
610008	5	357	610	250	1446	200	500	C

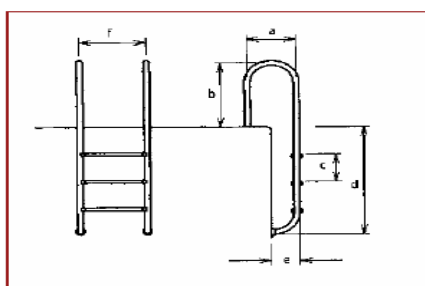

LADDERS

Stainless steel V2A Ø 43 mm handrail shiny polished. Stainless steel steps.
PVC anchorages.

MODEL STANDARD WITH ANATOMIC TREADS



Code	Steps	Dimensiones: mm						Rabat Group
		a	b	c	d	e	f	
610022	2	664	610	250	696	200	500	C
610023	3	664	610	250	946	200	500	C
610024	4	664	610	250	1196	200	500	C
610025	5	664	610	250	1446	200	500	C

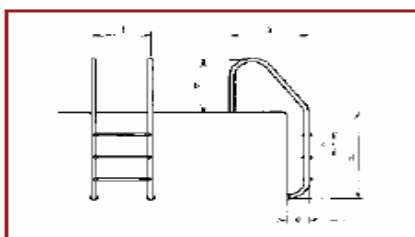

MODEL STANDARD WITH NON-SLIP TREADS



Code	Steps	Dimensiones: mm						Rabat Group
		a	b	c	d	e	f	
610001	2	664	610	250	696	200	500	C
610002	3	664	610	250	946	200	500	C
610003	4	664	610	250	1196	200	500	C
610004	5	664	610	250	1446	200	500	C

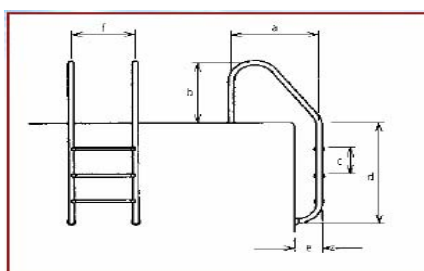

MODEL TWO PIECES WITH NON-SLIP TREADS



610013 Steps: 2		Dimensiones: mm				
a	b	c	d	e	f	q
440	778	250	515	225	200	500
610014 Steps: 3		Dimensiones: mm				
a	b	c	d	e	f	q
440	778	250	765	225	200	500
610015 Steps: 4		Dimensiones: mm				
a	b	c	d	e	f	q
440	778	250	1015	225	200	500
610016 Steps: 5		Dimensiones: mm				
a	b	c	d	e	f	q
440	778	250	1265	225	200	500

Rabat
Group
C

C

C

C

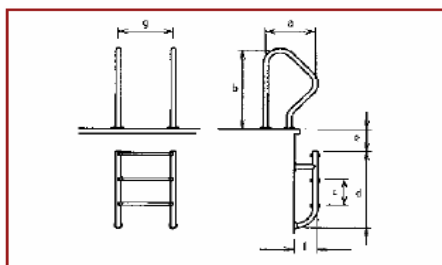

MODEL ABOVE GROUND

610034 3 x 3		Dimensiones: mm				
a	b	c	d	e	f	q
1223	1660	226	1052	366	483	690
610035 4 x 4		Dimensiones: mm				
a	b	c	d	e	f	q
1433	1886	226	1278	366	483	690
610036 5 x 5		Dimensiones: mm				
a	b	c	d	e	f	q
1643	2112	226	1504	366	483	690

Rabat
Group
C

C

C

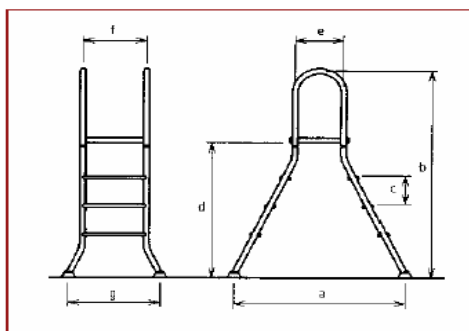

ACCESSORIES TO LADDERS



610018 Escutcheon

Rabat
Group

C

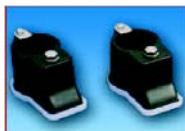

610019 Anchor - PVC

C



610020 End cap

C

610021 Anatomic tread

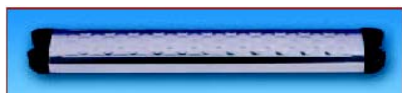

C

610037 Non-slip tread



C

610038 Safety double tread



C





610039 Screw with washer





C

HANDRAILS

Stainless steel V2A, handrail diameter 40 mm, for safety purposes of the lamellar covering.

		Rabat Group	Price in €
	630001 Infinity handrail 1 m	C	164
	630002 Infinity handrail 2 m	C	236
	630003 Infinity handrail 3 m	C	308
	630004 Handrail 0,5 m	C	62,4
	630005 Handrail 1 m	C	75,3
	630006 Handrail 1,5 m	C	87,1
	630007 Handrail 2 m	C	104,2
	630008 Handrail 3 m	C	134,5
	640006 AISI 304 - V2A hand rail Ø 43 - for concrete: each meter		56
	640007 Supports for stainless steel hand rail for concrete to fix to the wall: each		28
	640008 Supports for stainless steel hand rail complete with counterflange for prefabricated: each		92

EXIT HANDRAILS

		Dimensiones mm	Rabat Group	Price in €
	630009 Exit handrails SPA	a b c d 546 254 788	C	115,1
	630010 Exit handrails Figure 4	a b c d 817 203 1219 940	C	100,3
	630011 Exit handrails FX-01	a b c d 872 203 1219 940	C	126,8
	630012 Exit handrails FX-02	a b c d 817 203 1362 885	C	171,9

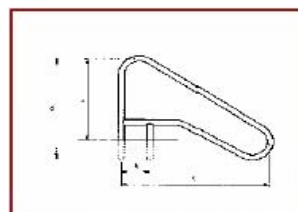
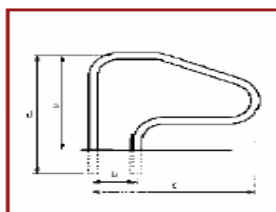
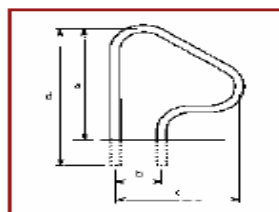

START PODIUM

AISI 316 L - V4A STAINLESS STEEL

Complete with: numbering on 4 sides and fixing stop.



640001 **STANDARD FIXED**
with incorporated rail and fiberglass platform (anti-slip)
FINA NORMS

640002 **STANDARD ADJUSTABLE**
with incorporated rail and fiberglass platform (anti-slip)
and step: FINA NORMS



640003 **HIGH ADJUSTABLE**
with incorporated rail and fiberglass platform (anti-slip)
and step: FINA NORMS

640004 **DIVING PLATE**
for starting block made of fiberglass (anti-slip)
cm. 50 x 50

640005 **BACKWARD DIVE RAIL**
with AISI 316 Stainless steel attachments flange
for fixing: FINA NORMS

**Rabat
Group**
G

G

G

G

G

FLOATING LINE AND ACCESSORIES

AISI 316 L - V4A STAINLESS STEEL

Rabat
Group

640009 **FLOATING LINE** (for competition)
Water breaks - with stainless steel plastic coated rope
FINA - CONI Norms - **for each mt.**

G

640010 **BELL ANCHORAGE**
for concrete - standard

G



640011 **BELL ANCHORAGE**
for liner pool

G



640012 **BELL ANCHORAGE**
with hidden hook for concrete

G

640013 **BELL ANCHORAGE**
with hidden hook for liner

G



640014 **BAYONET ANCHORAGE**
for pools with pool-level channel to be used with
the joint (code 640015)

G



640015 **FIXING BASE**
to be set into the paving to be used with
the joint (code 12103)

G

640016 **TENSIONER**
adjustable from both end - shiny finished

G



640017 **FLEXIBLE COUPLING SPRINGS**
heavy type - shiny finished

G

640018 **SPECIAL TENSIONER**
complete with safety cover

G

SHOWERS

Stainless steel V2A, diameter 43 mm, water connection: copper, external thread



620001	STANDARD			Dimensiones mm		
	a	b	c	d	e	f
	387	2287	1210		Ø 43	Ø 28

Rabat
Group
C



620002	STANDARD PLUS			Dimensiones mm		
	a	b	c	d	e	f
	387	2287	1210	450	Ø 43	Ø 28

C



620003	AUTOMATIC			Dimensiones mm		
	a	b	c	d	e	f
	387	2287	1210		Ø 63	Ø 28

C



620004	DOUBLE			Dimensiones mm		
	a	b	c	d	e	f
	810	2287	1210		Ø 63	Ø 28

C

SHOWERS

Stainless steel V4A, diameter 43 mm, water connection: copper, external thread

Rabat
Group



620005 **Infinity 1**
Cold water with drain cock



620006 **Infinity 1 plus**
Mixing battery with drain cock



620007 **Infinity 2**
Cold water with drain cock



620008 **Infinity 2 PLUS**
Mixing battery with drain cock

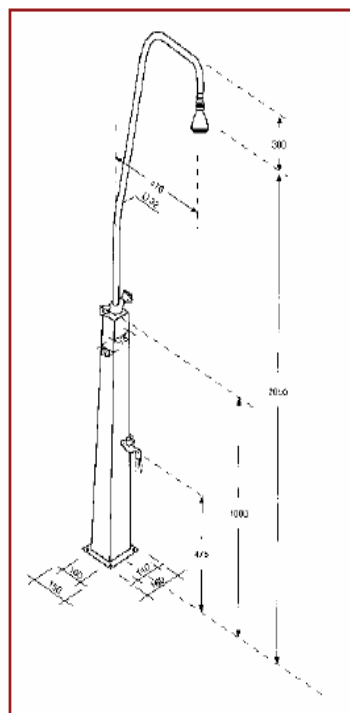

C

C

C

C

SHOWERS

Stainless steel V2A or V4A, diameter 43 mm, water connection: copper, external thread

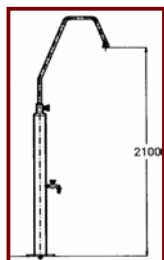

620027 **SUN**
 Ø 60, complete with cold water tap and foot bath tap -
 AISI 304 - V2A

G

620028 **SUN**
 Ø 76, complete with cold water tap and foot bath tap -
 AISI 304 - V2A

G

620011 **SUN**
 Ø 89, complete with cold water tap and foot bath tap -
 AISI 304 - V2A

G

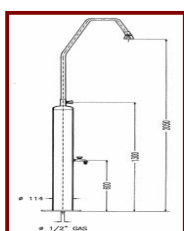

620012 **SUN**
 Ø 114, complete with cold water tap and foot bath tap -
 AISI 304 - V2A

G

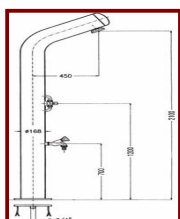

620013 **SUN**
 Ø 168, with N° 1 timing tap and foot bath tap -
 AISI 316L - V4A

G

620014 **SUN**
 Ø 220, with timing tap
 (30 litre water)

G

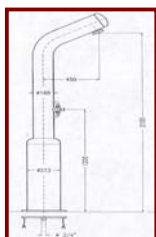

620015 **SUN**
 Ø 273, with N° 1 timing tap
 AISI 316L - V4A stainless steel

G

620016 **MAR D/1**
 complete with hot water tap and foot bath tap
 AISI 316L - V4A

G



620017 **MAR D/2**
 complete with hot and cold water taps, foot bath tap
 AISI 316L - V4A

G

620018 **MAR D/2 M**
 complete with mixer and foot bath tap
 AISI 316L - V4A

G

SHOWERS FOR PUBLIC SWIMMING POOLS

Rabat
Group
G

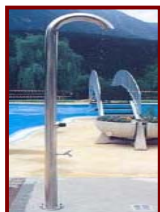

620019 **Ø 89 L**
complete with cold water timer tap and foot bath tap
AISI 316L - V4A stainless steel

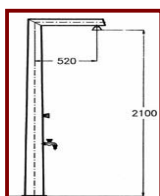

620020 **MAR D/1 L**
column - one arm with cold water tap and foot bath tap
AISI 316L - V4A stainless steel

G



620021 **MAR D/2L**
column - two arms with two cold water taps and two foot bath taps
AISI 316L - V4A stainless steel

G

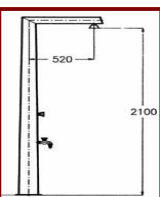

620022 **MAR D/1LT**
column - one arm with cold water timer tap and foot bath tap
AISI 316L - V4A stainless steel

G



620023 **MAR D/2LT**
column - two arms with two cold water push - bottoms taps and two foot bath taps
AISI 316L - V4A stainless steel

G



620024 **CACTUS**
sun-shower - four arms with water timer taps
AISI 316L - V4A stainless steel

G

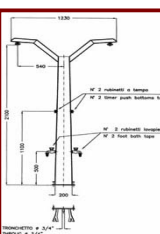

620025 **MAR D/2LT/N**
column - two arms with two cold water push-bottoms taps and two foot bath taps
AISI 316L - V4A stainless steel

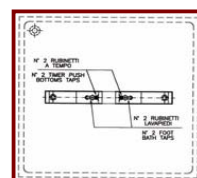

G

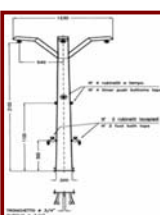

620026 **MAR D/4LT**
column - four arms with four cold water push-bottoms taps and two foot bath taps
AISI 316L - V4A stainless steel

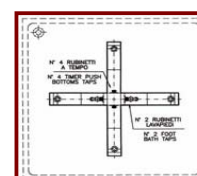

G

ACCESSORIES TO SHOWER



- 620009 Ø 43 Anchor shower
620010 Ø 63 Anchor shower

Rabat
Group
C
C

FIBERGLASS SHOWER PLATES

- 620029 **Fiberglass shower plate**
80 x 80 cm height: 13 cm
- 620030 **Fiberglass shower plate**
90 x 90 cm height: 14 cm
- 620031 **Fiberglass shower plate**
92 x 92 cm height: 20 cm
- 620032 **Fiberglass shower plate**
235 x 180 cm height: 20 cm
- 620033 **Drilling of shower tray with drain**

Rabat
Group
G
G
G
G
G

STAINLESS STEEL FOOT-BATH COLUMN

AISI 316L - V4A



- 620034 **Complete with n° 1 DELUXE**
timer tap (only cold water)

Rabat
Group
G



- 620035 **Complete with n° 2 DELUXE**
timer tap (only cold water)

G



- 620036 **ISI 316L-V4A stainless steel Basement**
for single column, complete with drain

G

- 620037 **ISI 316L-V4A stainless steel Basement**
for double column and drain

G

OVERFLOW GRATINGS

OWERFLOW GRATINGS CURVE MODULE

			Rabat Group	
	540100	25 X 145 mm	42 units/1 m	C
	540101	25 x 196 mm	43 units/1 m	C
	540102	25 x 200 mm	41 units/1 m	C
	540103	25 x 245 mm	42 units/1 m	C
	540112	20 x 295 mm	45 units/1 m	C
	540113	34 x 295 mm	45 units/1 m	C

OWERFLOW GRATINGS

			Rabat Group	
	540104	25 x 196 mm	51 units/1 m	C
	540105	25 x 245 mm	53 units/1 m	C
	540114	20 x 295 mm	45 units/1 m	C
	540115	35 x 295 mm	45 units/1 m	C

OWERFLOW CORNER 90°

			Rabat Group	
	540106	22 x 150 mm		C
	540107	22 x 200 mm		C
	540108	22 x 250 mm		C
	540116	20 x 300 mm		C
	540117	34 x 300 mm		C

OWERFLOW CORNER 45°

			Rabat Group	
	540109	22 x 150 mm		C
	540110	22 x 200 mm		C
	540111	22 x 250 mm		C
	540118	20 x 300 mm		C
	540119	34 x 300 mm		C

OWERFLOW GRATE CHANEL PROFILE

		Rabat Group
540200	Profil 2 m- 1 piece	C